



Monocrystalline Module

Dimensions: 1002*1979*35mm
Mono Power: 380W



380W

Max power output

19.16%

Max Efficiency

± 3%

Positive Power Tolerance

SUNWORTH - Your Trusted Brand of High Quality

- Professional crystalline silicon photovoltaic module manufacturer.
- Fully automated production line with leading photovoltaic technology.
- Adopt strict international standard quality management system ISO 9001:2015, ISO14001: 2015.
- Passed variety of harsh environmental tests (salt spray, ammonia and sand storm corrosion test IEC61730-2:2016, IEC61215:2016).
- Twice EL test to ensure the reliability of the solar modules.



5 Bus Bar Solar Cells

5 BB solar cells, improve the modules' efficiency ,and contributed a better aesthetic appearance



High Efficiency

High efficiency solar cells to keep the module efficiency reach to 19.16%



Low-light Performance

Advanced glass and cell surface textured design ensure excellent performance in low-light environment



PID Resistance

Excellent Anti-PID performance guarantee limited power degradation for mass production



Severe Weather Resilience

2400 Pa wind load
5400 Pa snow load



100% EL Testing

100% EL detection before and after lamination

Linear Performance Warranty

10 years Product Warranty

25 years Linear Power Warranty

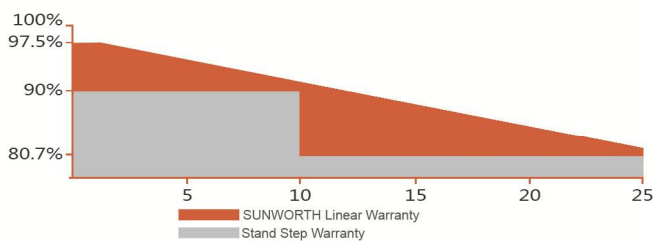

Dimensions: 1002*1979*35mm
Mono Power: 380W

Electrical Characteristics

Model No.	SW380MP-72
Maximum Power (Pmax)	380W
Max-power Voltage (Vmp)	39.92V
Max-power Current (Imp)	9.52A
Open-circuit Voltage (Voc)	49.14V
Short-circuit Current (Isc)	10.22A
Module Efficiency	19.16%
Operating Temperature	-40°C~+85°C
Maximum System Voltage	1000Vdc
Maximum Series Fuse Rating	15A
Power Tolerance	±3%

*STC condition: 1000 W/m², 1.5AM and 25°C cell temperature

Temperature Characteristics

NMOT	46°C±2°C
Temperature Co-efficient of Pmax	-0.398%/°C
Temperature Co-efficient of Voc	-0.340%/°C
Temperature Co-efficient of Isc	0.0576%/°C

Mechanical Characteristics

Mono Power	380W
Cell Type	Mono 158.75*158.75mm
Cell Arrangement	72(6*12)
Dimensions	1002*1979*35mm
Weight	21.0kg
Front Cover	3.2mm tempered glass
Frame Material	Anodized aluminium alloy
Junction Box	IP67 rated
Output Cables	4mm ² , Length 900mm+MC4

Packing

Packing	20'GP	40'HC
Pieces per Carton	30	30
Pieces/container	300	660

Module Size

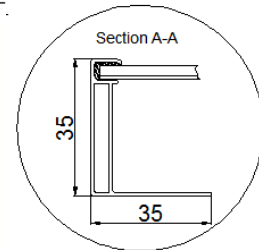
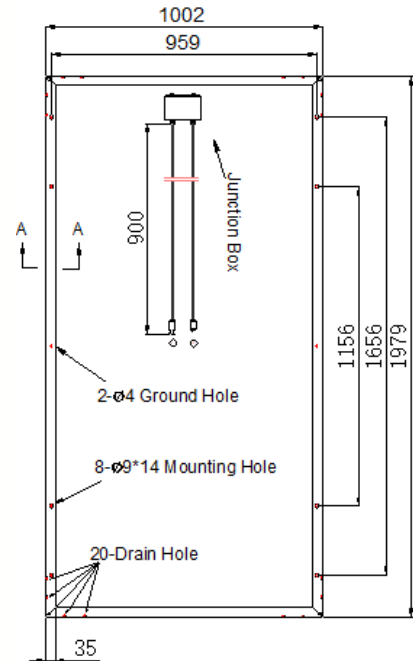

I-V Curve

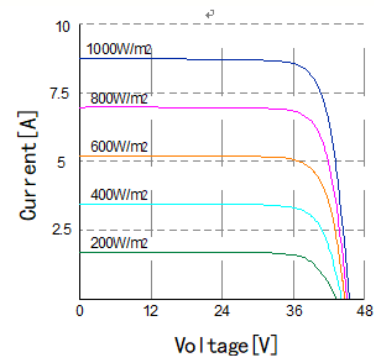

SUNWORTH solar modules have superior performance under low solar irradiation condition (200W/m² (AM1.5, 25 °C)

Website: www.sunworthsolar.com